

***VERSA COMM+4/EX™***  
***USER MANUAL***

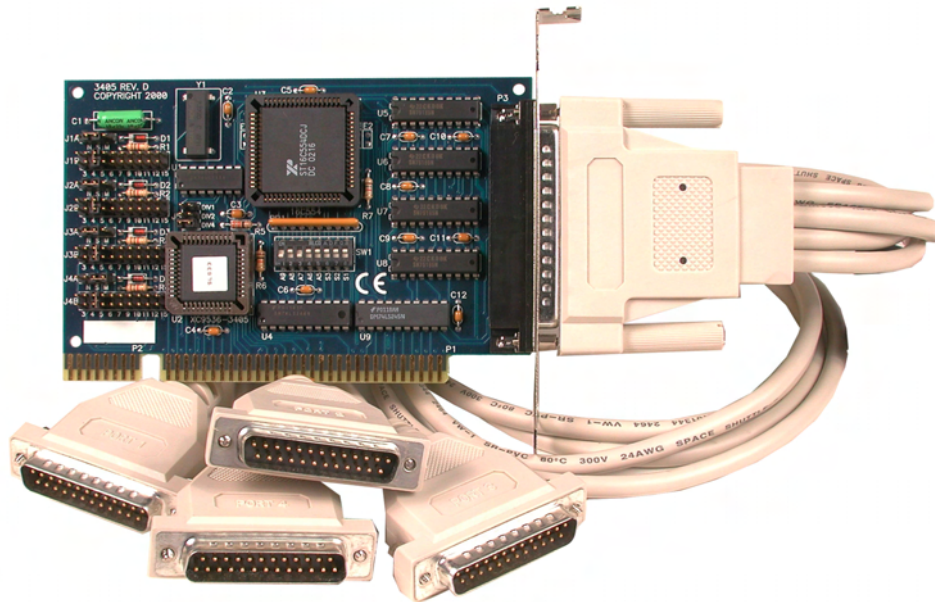

**Part #3405**

---

Sealevel Systems, Inc.  
PO Box 830  
Liberty, SC 29657 USA

Telephone: (864) 843-4343  
Fax: (864) 843-3067  
[www.sealevel.com](http://www.sealevel.com)

## *Contents*

<b>INTRODUCTION .....</b>	<b>1</b>
OVERVIEW .....	1
WHAT'S INCLUDED.....	1
FACTORY DEFAULT SETTINGS .....	1
<b>CARD SETUP .....</b>	<b>2</b>
ADDRESS SELECTION.....	2
JUMPER SELECTIONS .....	4
IRQ Selection.....	4
INTERRUPT MODES.....	5
CLOCK MODES .....	6
BAUD RATES AND DIVISORS FOR THE 'DIV1' MODE .....	7
BAUD RATES AND DIVISORS FOR THE 'DIV2' MODE .....	8
<b>INSTALLATION .....</b>	<b>9</b>
OPERATING SYSTEM INSTALLATION .....	9
For Windows Users.....	9
Other Operating Systems .....	9
SYSTEM INSTALLATION .....	9
<b>TECHNICAL DESCRIPTION .....</b>	<b>10</b>
FEATURES.....	10
INTERRUPT STATUS PORT.....	10
CONNECTOR PIN ASSIGNMENTS.....	11
DB-25 Male (RS-232 DTE).....	11
DB-9 Male (EIA-574 DTE).....	11
DB-37 Male .....	12
<b>SPECIFICATIONS .....</b>	<b>13</b>
ENVIRONMENTAL SPECIFICATIONS .....	13
MANUFACTURING.....	13
POWER CONSUMPTION .....	13
MEAN TIME BETWEEN FAILURES (MTBF).....	13
PHYSICAL DIMENSIONS.....	13
<b>APPENDIX A - TROUBLESHOOTING .....</b>	<b>14</b>
<b>APPENDIX B - HOW TO GET ASSISTANCE.....</b>	<b>16</b>
<b>APPENDIX C - ELECTRICAL INTERFACE .....</b>	<b>17</b>
RS-232 .....	17
<b>APPENDIX D - ASYNCHRONOUS COMMUNICATIONS.....</b>	<b>18</b>

<b>APPENDIX E - SILK-SCREEN .....</b>	<b>19</b>
<b>APPENDIX F - SCHEMATIC .....</b>	<b>20</b>
<b>APPENDIX G - COMPLIANCE NOTICES .....</b>	<b>22</b>
FEDERAL COMMUNICATIONS COMMISSION STATEMENT.....	22
EMC DIRECTIVE STATEMENT .....	22
<b>WARRANTY.....</b>	<b>23</b>

### *Figures*

<b>Figure 1 - Available Address Combinations .....</b>	<b>2</b>
<b>Figure 2 - Address Selection Table .....</b>	<b>3</b>
<b>Figure 3 - Port to Connector Table .....</b>	<b>3</b>
<b>Figure 4 – Headers J1B – J4B, IRQ Selection .....</b>	<b>4</b>
<b>Figure 5 - Header J1A, Normal IRQ Mode .....</b>	<b>5</b>
<b>Figure 6 - Header J1A &amp; J2A, Shared IRQ Mode .....</b>	<b>5</b>
<b>Figure 7 - Clocking Mode ‘Divide By 4’ .....</b>	<b>6</b>
<b>Figure 8 - Clocking Mode ‘Divide By 2’ .....</b>	<b>6</b>
<b>Figure 9 - Clocking Mode ‘Divide By 1’ .....</b>	<b>6</b>
<b>Figure 10 - Asynchronous Communications Bit Diagram .....</b>	<b>18</b>

© Sealevel Systems, Inc.  
SL9144 Revision 7/2006  
Sealevel Systems, Incorporated. All rights reserved.

## Introduction

### Overview

The Sealevel Systems **VERSA COMM+4/EX** provides the PC with four RS-232 asynchronous ports. The **VERSA COMM+4/EX** allows for connection to any device utilizing the RS-232 electrical interface, such as modems, data-entry terminals, and plotters.

### What's Included

The **VERSA COMM+4/EX** is shipped with the following items. If any of these items is missing or damaged, contact the supplier.

- **VERSA COMM+4/EX** Serial I/O Adapter
- DB-37 to four DB-25 'Spider Cable' (DB-9 Spider Cable is available)
- Sealevel Software

### Factory Default Settings

The **VERSA COMM+4/EX** factory default settings are as follows:

Port #	Base Address	IRQ	IRQ Mode	Clock Divisor
Port 1	280	5	M	4
Port 2	288	5	S	4
Port 3	290	5	S	4
Port 4	298	5	S	4

To install the **VERSA COMM+4/EX** using factory default settings, refer to Installation on page 9.

For your reference, record installed **VERSA COMM+4/EX** settings below:

Port #	Base Address	IRQ	IRQ Mode	Clock Divisor
Port 1				
Port 2				
Port 3				
Port 4				

---

## Card Setup

The **VERSA COMM+4/EX** contains several jumper straps that must be set for proper operation.

### Address Selection

Each port on the **VERSA COMM+4/EX** occupies eight consecutive I/O locations. A DIP-switch is used to set the base address for these locations.

The **VERSA COMM+4/EX** has a unique addressing scheme that allows it to be completely compatible with Sealevel Systems' older four port RS-232 interface adapters (p/n 3064, 3065, 3066 and 3400) and provides the ability to select specific non-linear address combinations (i.e. 3F8, 2F8, 3E8, 2E8).

The first addressing scheme allows the user to select the addresses for its ports from a table of available address combinations.

The following table shows the addressing combinations available. If different address combinations are required, please contact Sealevel Systems Technical Support about custom PAL options.

Switch 6	Switch 7	Switch 8	Port 1	Port 2	Port 3	Port 4
On	On	Off	3F8	2F8	3E8	2E8
On	Off	On	2F8	3E8	2E8	2E0
On	Off	Off	3E8	2E8	280	288
Off	On	On	500	508	510	518
Off	On	Off	580	588	590	598
Off	Off	On	1500	1508	1510	1518
Off	Off	Off	3220	3228	4220	4228
On	On	On	Addresses set up by switches 1 - 5			

*Figure 1 - Available Address Combinations*

**Note:** Each COM: port in the system should have a unique address. Typically COM1: - COM4: addresses are 3F8, 2F8, 3E8 and 2E8 Hex.

Refer to Appendix A for common address contentions.

The second mode of address selection provides the compatibility mode. In this mode the DIP-switch sets the base address and the adapter occupies 32 consecutive I/O locations. The following table illustrates the location of each port and its relationship to the other ports.

**Note:** For switches 1 - 5 to become active, switches 6, 7 & 8 must be set in the 'On' or 'Up' position.

Address lines →	Switch Settings				
	A9	A8	A7	A6	A5
<b>Address Selected</b>	<b>1</b>	<b>2</b>	<b>3</b>	<b>4</b>	<b>5</b>
280-29F	Off	On	Off	On	On
2A0-2BF	Off	On	Off	On	Off
380-39F	Off	Off	Off	On	On
1A0-1BF	On	Off	Off	On	Off
2E0-2FF	Off	On	Off	Off	Off

Figure 2 - Address Selection Table

The following illustration shows the correlation between the DIP-switch setting and the address bits used to determine the base address. In the example below, address 2E0 is selected as a base. Address 2E0 in binary is XX 10 111X XXXX where X = a non-selectable address bit.

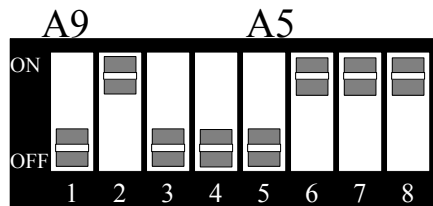

Port #	Connector Location	Address	Example (Base=2E0)
1	1	Base+0	2E0-2E7
2	2	Base+8	2E8-2EF
3	3	Base+16	2F0-2F7
4	4	Base+24	2F8-2FF

Figure 3 - Port to Connector Table

## Jumper Selections

For ease of configuration, the headers are grouped by port. Port one headers have a 'J1' prefix, Port two headers have the 'J2' prefix, etc. For example, the header that controls the Port one IRQ selection is J1B, the header that controls the Port 2 IRQ selection is J2B. The silk-screen also provides information for configuring the adapter without the use of the manual. This is particularly useful in field re-configuration.

## IRQ Selection

Headers J1B through J4B select the interrupt request for each serial port. If COM1: is selected, the corresponding jumper must be on the IRQ4 setting. If COM2: is selected, the corresponding jumper must be on IRQ3. (This only applies to the traditional DOS COM: port assignments, in Windows COM1: can use I/O address 300 and IRQ15 if it is available!)

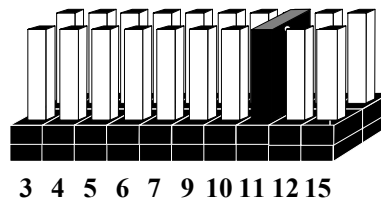

*Figure 4 – Headers J1B – J4B, IRQ Selection*

**Note:** Most DOS communications software applications default COM3: to IRQ4 and COM4: to IRQ3. This requires the sharing of interrupts between COM1: and COM3:, and between COM2: and COM4:. While this is the default, it is not always the preferred setting. Check your software configuration instructions to determine the most appropriate IRQ selection.

Any two or more ports can share a common IRQ by placing the jumpers on the same IRQ setting and setting the appropriate selections at J1A through J4A. When sharing IRQs, many operating systems (i.e. Windows NT) will require the location of the **Interrupt Status Port (ISP)**. Please see Page 10 for a description of the ISP and how it is used.

## Interrupt Modes

Headers J1A through J4A select the interrupt modes for each port. Each port must be set in the correct mode to insure proper operation.

‘N’ indicates the (N)ormal, single interrupt per port mode. ‘S’ Indicates the (S)hared interrupt mode, which allows more than one port to access a single IRQ. ‘M’ indicates the inclusion of a 1K ohm pull-down resistor required on one port when sharing interrupts.



*Figure 5 - Header J1A, Normal IRQ Mode*

Set the jumpers to ‘S’ for shared interrupt mode on all blocks sharing an IRQ except one. Set that port block for ‘M’. This provides the pull-down resistor circuit that makes sharing IRQs possible. If you are using more than one **VERSA COMM+4/EX** or a compatible adapter in a bus you should only have one port set to ‘M’. The following example shows two ports sharing a single IRQ.

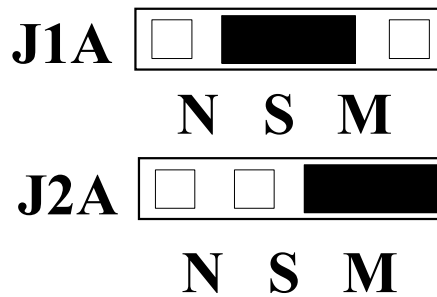

*Figure 6 - Header J1A & J2A, Shared IRQ Mode*

Set the jumper to ‘S’ if you are using more than one **VERSA COMM+4/EX** in a bus or to completely remove the pull-down resistor for hardware compatibility. **Setting the adapter in this configuration when it is not accompanied by a pull-down resistor will prevent the ports from triggering an interrupt.**



---

**Clock Modes**

The **VERSA COMM+4/EX** employs a unique clocking option that allows the end user to select from divide by 4, divide by 2 and divide by 1 clocking modes. This mode is selected at J5.

To select the Baud rates commonly associated with COM: ports (i.e. 2400, 4800, 9600, 19.2, ... 115.2K Bps) place the jumper in the divide by 4 mode (silk-screen DIV4).

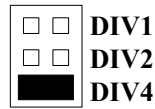

*Figure 7 - Clocking Mode 'Divide By 4'*

To double these rates up to a maximum rate for 230.4K bps place the jumper in the divide by 2 (silk-screen DIV2) position.

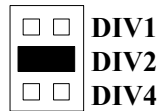

*Figure 8 - Clocking Mode 'Divide By 2'*

To select the maximum data rate (460.8K bps) place the jumper in the divide by 1 (silk-screen DIV1) position.

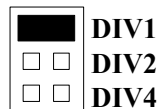

*Figure 9 - Clocking Mode 'Divide By 1'*

---

**Baud Rates and Divisors for the 'Div1' mode**

The following table shows some common data rates and the rates you should choose to match them if using the adapter in the 'Div1' mode.

<b>For this Data Rate</b>	<b>Choose this Data Rate</b>
1200 bps	300 bps
2400 bps	600 bps
4800 bps	1200 bps
9600 bps	2400 bps
19.2K bps	4800 bps
57.6 K bps	9600 bps
115.2 K bps	19.2K bps
230.4K bps	57.6 K bps
460.8K bps	115.2 K bps

If your communications package allows the use of Baud rate divisors, choose the appropriate divisor from the following table:

<b>For this Data Rate</b>	<b>Choose this Divisor</b>
1200 bps	384
2400 bps	192
4800 bps	96
9600 bps	48
19.2K bps	24
38.4K bps	12
57.6K bps	8
115.2K bps	4
230.4K bps	2
460.8K bps	1

**Baud Rates and Divisors for the 'Div2' mode**

The following table shows some common data rates and the rates you should choose to match them if using the adapter in the 'Div2' mode.

<b>For this Data Rate</b>	<b>Choose this Data Rate</b>
1200 bps	600 bps
2400 bps	1200 bps
4800 bps	2400bps
9600 bps	4800 bps
19.2K bps	9600 bps
38.4K bps	19.2K bps
57.6 K bps	38.4K bps
115.2 K bps	57.6 K bps
230.4 K bps	115.2 K bps

If your communications package allows the use of Baud rate divisors, choose the appropriate divisor from the following table:

<b>For this Data Rate</b>	<b>Choose this Divisor</b>
1200 bps	192
2400 bps	96
4800 bps	48
9600 bps	24
19.2K bps	12
38.4K bps	8
57.6K bps	4
115.2K bps	2
230.4K bps	1

## Installation

### Operating System Installation

#### For Windows Users

Start by choosing **Install Software at the beginning of the CD. Choose Asynchronous COM: Port Software, SeaCOM.**

#### Other Operating Systems

Refer to the appropriate section of the Serial Utilities Software.

### System Installation

The **VERSA COMM+4/EX** can be installed in any of the PC ISA expansion slots. The **VERSA COMM+4/EX** contains several jumper straps for each port that must be set for proper operation.

1. Turn off PC power. Disconnect the power cord.
2. Remove the PC case cover.
3. Locate an available slot and remove the blank metal slot cover.
4. Gently insert the **VERSA COMM+4/EX** into the slot. Make sure that the adapter is seated properly.
5. Replace the screw.
6. Replace the cover.
7. Install the "Spider Cable".
8. Connect the power cord.

Installation is complete.

## Technical Description

The **VERSA COMM+4/EX** utilizes the 16C554 UART. This chip features programmable baud rate, data format, interrupt control and a 16-byte input and output FIFO, and is functionally 4 16C550 UARTs. A full array of advanced UARTs is also available for this card. Contact Sealevel Systems, Inc. for more information.

### Features

- ‘Shareable’ IRQs allow more than one port to share a single IRQ with appropriate software drivers
- IRQs 3-7, 9-12, 15 supported
- 16C554 buffered Quad UART Standard
- 16 Bit address decode allows for easier integration
- Speeds up to 460.8 K bps
- Multiple clocking modes insuring compatibility with existing software products

### Interrupt Status Port

The **VERSA COMM+4/EX** provides the user with an **Interrupt Status Port (ISP)** for greater throughput when servicing multiple ports on a single interrupt line. The ISP is a read only 8-bit register that sets a corresponding bit when an interrupt is pending. Port 1 interrupt line corresponds with Bit D0 of the status port, Port 2 with D1 etc.

The ISP is located at Base+7 on each port (Example: Base = 280 Hex, Status Port = 287, 28F... etc.). This allows any one of eight locations to be read to obtain the value in the status register. All four status ports on the **VERSA COMM+4/EX** are identical, so any one of the four can be read to determine which interrupt is pending. In the following example Channel 2 has an interrupt pending. D4 through D7 are not driven into the interrupt status register and can be 1’s or 0’s.

Bit Position:	7	6	5	4	3	2	1	0
Value Read:	0	0	0	0	0	0	1	0

---

**Connector Pin Assignments**

**DB-25 Male (RS-232 DTE)**

Signal	Name	Pin #	Mode
GND	Ground	7	
TD	Transmit Data	2	Output
RTS	Request To Send	4	Output
DTR	Data Terminal Ready	20	Output
RD	Receive Data	3	Input
CTS	Clear To Send	5	Input
DSR	Data Set Ready	6	Input
DCD	Data Carrier Detect	8	Input
RI	Ring Indicator	22	Input

**DB-9 Male (EIA-574 DTE)**

Signal	Name	Pin #	Mode
GND	Ground	5	
TD	Transmit Data	3	Output
RTS	Request To Send	7	Output
DTR	Data Terminal Ready	4	Output
RD	Receive Data	2	Input
CTS	Clear To Send	8	Input
DSR	Data Set Ready	6	Input
DCD	Data Carrier Detect	1	Input
RI	Ring Indicator	9	Input

**DB-37 Male**

<b>Port #</b>	<b>1</b>	<b>2</b>	<b>3</b>	<b>4</b>
GND	33	14	24	5
TD	35	12	26	3
RTS	17	30	8	21
DTR	34	13	25	4
RD	36	11	27	2
CTS	16	31	7	22
DSR	18	29	9	20
DCD	37	10	28	1
RI	15	32	6	23

*Technical Note:* Please terminate any control signals that are not going to be used. The most common way to do this is connect RTS to CTS and RI. Also, connect DCD to DTR and DSR. Terminating these pins, if not used, will help insure you get the best performance from your adapter.

---

## Specifications

### Environmental Specifications

Specification	Operating	Storage
Temperature Range	0° to 50° C (32° to 122° F)	-20° to 70° C (-4° to 158° F)
Humidity Range	10 to 90% R.H. Non-Condensing	10 to 90% R.H. Non-Condensing

### Manufacturing

- All Sealevel Systems Printed Circuit boards are built to U.L. 94V0 rating and are 100% electrically tested. These printed circuit boards are solder mask over bare copper or solder mask over tin nickel.

### Power Consumption

Supply line	+12 VDC	-12 VDC	+5 VDC
Rating	60 mA	80 mA	210 mA

### Mean Time Between Failures (MTBF)

Greater than 150,000 hours. (Calculated)

### Physical Dimensions

Board length	5.2 inches	(13.208 cm.)
Board Height including Goldfingers	3.4 inches	(8.636 cm.)
Board Height excluding Goldfingers	3.1 inches	(7.874 cm.)



## Appendix A - Troubleshooting

Serial Utility test software is supplied with the Sealevel Systems adapter and will be used in the troubleshooting procedures. By using this software and following these simple steps, most common problems can be eliminated without the need to call Technical Support.

1. Identify all I/O adapters currently installed in your system. This includes your on-board serial ports, controller cards, sound cards etc. The I/O addresses used by these adapters, as well as the IRQ (if any) should be identified.
2. Configure your Sealevel Systems adapter so that there is no conflict with currently installed adapters. No two adapters can occupy the same I/O address.
3. Make sure the Sealevel Systems adapter is using a unique IRQ. The IRQ is typically selected via an on-board header block. Refer to the section on Card Setup for help in choosing an I/O address and IRQ.
4. Make sure the Sealevel Systems adapter is securely installed in a motherboard slot.
5. When running DOS, Windows 3.x or other operating systems refer to the Serial Utilities software for that operating system and the User Manual to verify that the Sealevel Systems adapter is configured correctly. The supplied software contains a diagnostic program 'SSD' that runs under DOS and will verify if an adapter is configured properly. This diagnostic program is written with the user in mind and is easy to use. Refer to the DIAG.txt file in the dos\diag directory for detailed instructions on using 'SSD'.
6. For Windows 95/98 and Windows NT, the diagnostic tool 'WinSSD' is installed in the Sealevel folder on the Start Menu during the setup process. First find the ports using the Device Manager, then use 'WinSSD' to verify that the ports are functional.
7. Always use the Sealevel Systems diagnostic software when troubleshooting a problem. This will help eliminate any software issues and identify any hardware conflicts.

8. The following are known I/O conflicts:

- The 278 and 378 settings may conflict with your printer I/O adapter.
- 3B0 cannot be used if a Monochrome adapter is installed.
- 3F8-3FF is typically reserved for COM1:
- 2F8-2FF is typically reserved for COM2:
- 3E8-3EF is typically reserved for COM3:
- 2E8-2EF is typically reserved for COM4:

## Appendix B - How To Get Assistance

Please refer to Troubleshooting Guide prior to calling Technical Support.

1. Begin by reading through the Trouble Shooting Guide in Appendix A. If assistance is still needed please see below.
2. When calling for technical assistance, please have your user manual and current adapter settings. If possible, please have the adapter installed in a computer ready to run diagnostics.
3. Sealevel Systems provides an FAQ section on its web site. Please refer to this to answer many common questions. This section can be found at <http://www.sealevel.com/faq.htm>.
4. Sealevel Systems maintains a Home page on the Internet. Our home page address is [www.sealevel.com](http://www.sealevel.com). The latest software updates, and newest manuals are available via our FTP site that can be accessed from our home page.
5. Technical support is available Monday to Friday from 8:00 a.m. to 5:00 p.m. eastern time. Technical support can be reached at (864) 843-4343.

**RETURN AUTHORIZATION MUST BE OBTAINED FROM SEALEVEL SYSTEMS BEFORE RETURNED MERCHANDISE WILL BE ACCEPTED. AUTHORIZATION CAN BE OBTAINED BY CALLING SEALEVEL SYSTEMS AND REQUESTING A RETURN MERCHANDISE AUTHORIZATION (RMA) NUMBER.**

## Appendix C - Electrical Interface

### RS-232

Quite possibly the most widely used communication standard is RS-232. This implementation has been defined and revised several times and is often referred to as RS-232-C/D/E or EIA/TIA-232-C/D/E. It is defined as “*Interface between Data Terminal Equipment and Data Circuit-Terminating Equipment Employing Serial Binary Data Interchange*”. The mechanical implementation of RS-232 is on a 25-pin D sub connector. The IBM PC computer defined the RS-232 port on a 9 pin D sub connector and subsequently the EIA/TIA approved this implementation as the EIA/TIA-574 standard. This standard has defined as the “*9-Position Non-Synchronous Interface between Data Terminal Equipment and Data Circuit-Terminating Equipment Employing Serial Binary Data Interchange*”. Both implementations are in wide spread use and will be referred to as RS-232 in this document. RS-232 is capable of operating at data rates up to 20K bps / 50 ft. The absolute maximum data rate may vary due to line conditions and cable lengths. RS-232 often operates at 38.4K bps over very short distances. The voltage levels defined by RS-232 range from -12 to +12 volts. RS-232 is a single ended or unbalanced interface, meaning that a single electrical signal is compared to a common signal (ground) to determine binary logic states. A voltage of +12 volts (usually +3 to +10 volts) represents a binary 0 (space) and -12 volts (-3 to -10 volts) denote a binary 1 (mark). The RS-232 and the EIA/TIA-574 specification define two types of interface circuits **Data Terminal Equipment (DTE)** and **Data Circuit-Terminating Equipment (DCE)**. The Sealevel Systems Adapter is a DTE interface.

## Appendix D - Asynchronous Communications

Serial data communications implies that individual bits of a character are transmitted consecutively to a receiver that assembles the bits back into a character. Data rate, error checking, handshaking, and character framing (start/stop bits) are pre-defined and must correspond at both the transmitting and receiving ends.

Asynchronous communications is the standard means of serial data communication for PC compatibles and PS/2 computers. The original PC was equipped with a communication or COM: port that was designed around an 8250 Universal Asynchronous Receiver Transmitter (UART). This device allows asynchronous serial data to be transferred through a simple and straightforward programming interface. A starting bit followed by a pre-defined number of data bits (5, 6, 7, or 8) defines character boundaries for asynchronous communications. The end of the character is defined by the transmission of a pre-defined number of stop bits (usually 1, 1.5 or 2). An extra bit used for error detection is often appended before the stop bits.

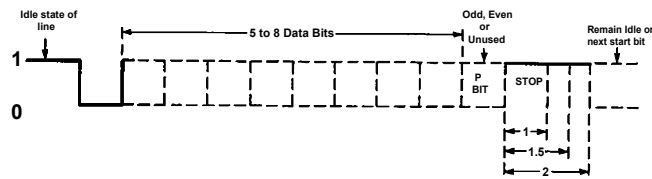
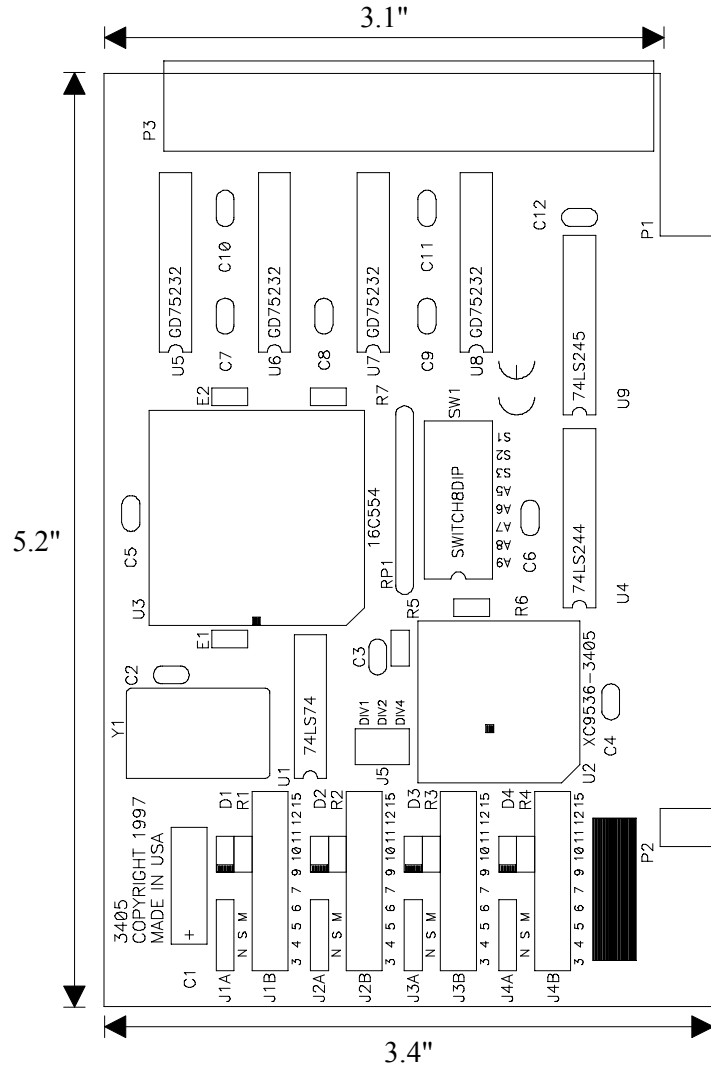

Figure 10 - Asynchronous Communications Bit Diagram

This special bit is called the parity bit. Parity is a simple method of determining if a data bit has been lost or corrupted during transmission. There are several methods for implementing a parity check to guard against data corruption. Common methods are called (E)ven Parity or (O)dd Parity. Sometimes parity is not used to detect errors on the data stream. This is referred to as (N)o parity. Because each bit in asynchronous communications is sent consecutively, it is easy to generalize asynchronous communications by stating that each character is wrapped (framed) by pre-defined bits to mark the beginning and end of the serial transmission of the character. The data rate and communication parameters for asynchronous communications have to be the same at both the transmitting and receiving ends. The communication parameters are baud rate, parity, number of data bits per character, and stop bits (i.e. 9600,N,8,1).

### Appendix E - Silk-Screen



## Appendix F - Schematic

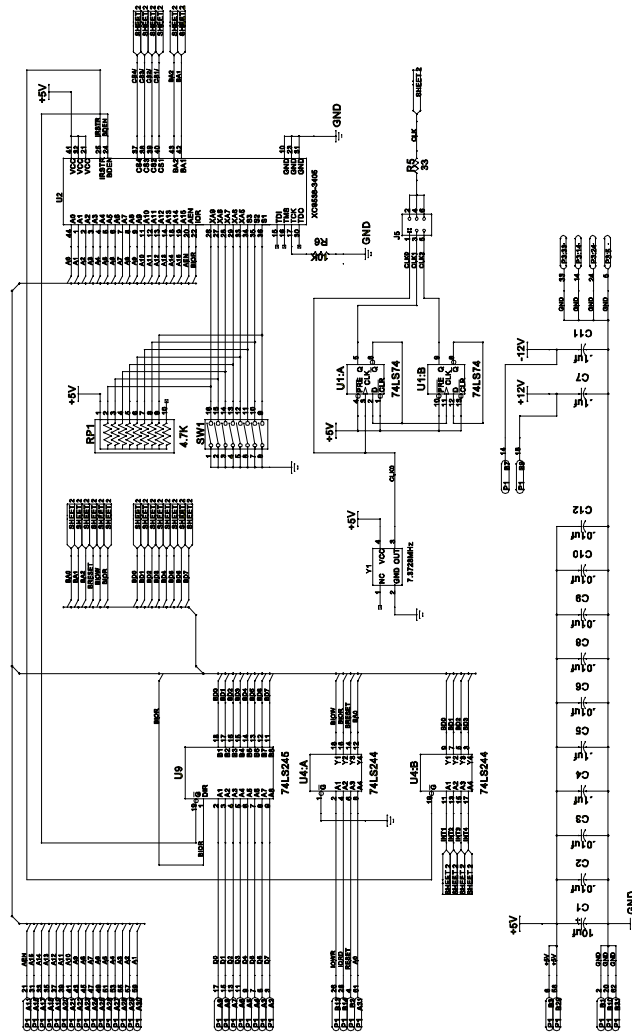

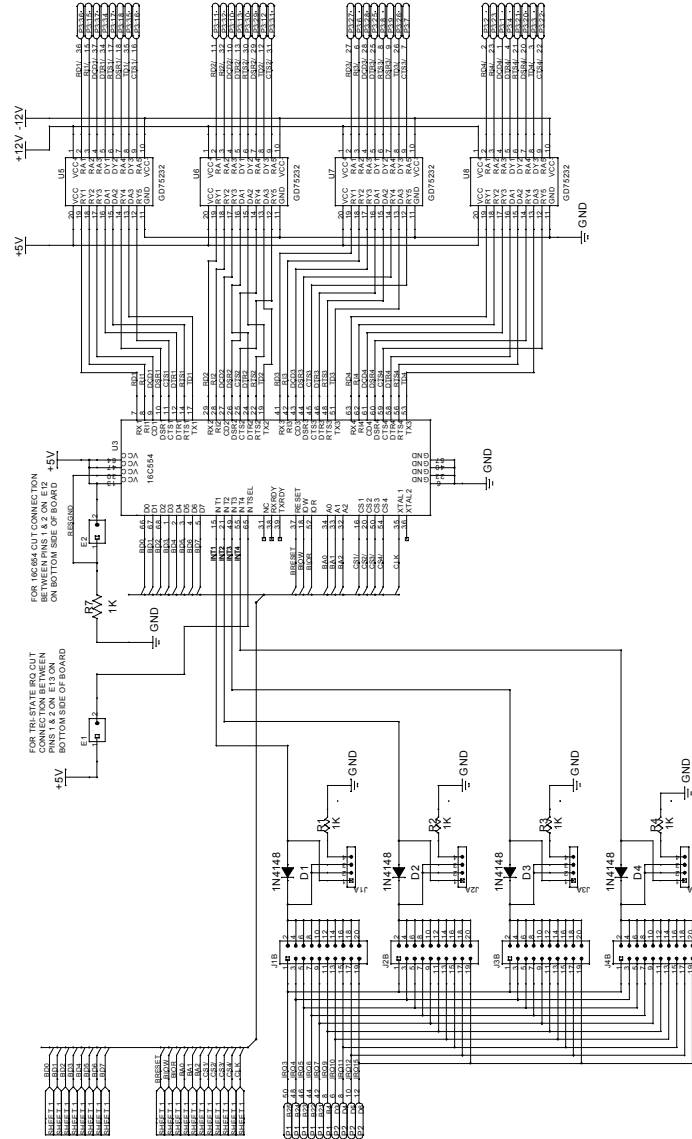



## Appendix G - Compliance Notices

### Federal Communications Commission Statement

FCC - This equipment has been tested and found to comply with the limits for Class A digital device, pursuant to Part 15 of the FCC Rules. These limits are designed to provide reasonable protection against harmful interference when the equipment is operated in a commercial environment. This equipment generates, uses, and can radiate radio frequency energy and, if not installed and used in accordance with the instruction manual, may cause harmful interference to radio communications. Operation of this equipment in a residential area is likely to cause harmful interference. In such case the user will be required to correct the interference at his own expense.

### EMC Directive Statement



Products bearing the CE Label fulfill the requirements of the EMC directive (89/336/EEC) and of the low-voltage directive (73/23/EEC) issued by the European Commission.

To obey these directives, the following European standards must be met:

- **EN55022 Class A** - “Limits and methods of measurement of radio interference characteristics of information technology equipment”
- **EN55024**-‘Information technology equipment Immunity characteristics Limits and methods of measurement.
- **EN60950 (IEC950)** - “Safety of information technology equipment, including electrical business equipment”

#### Warning

**This is a Class A Product. In a domestic environment this product may cause radio interference in which case the user may be required to take adequate measures.**

Always use cabling provided with this product if possible. If no cable is provided or if an alternate cable is required, use high quality shielded cabling to maintain compliance with FCC/EMC directives.

## Warranty



Sealevel Systems, Inc. provides a limited lifetime warranty. Should this product fail to be in good working order at any time during this period, Sealevel Systems will, at its option, replace or repair it at no additional charge except as set forth in the following terms. This warranty does not apply to products damaged by misuse, modifications, accident or disaster.

Sealevel Systems assumes no liability for any damages, lost profits, lost savings or any other incidental or consequential damage resulting from the use, misuse of, or inability to use this product. Sealevel Systems will not be liable for any claim made by any other related party.

**RETURN AUTHORIZATION MUST BE OBTAINED FROM SEALEVEL SYSTEMS BEFORE RETURNED MERCHANDISE WILL BE ACCEPTED. AUTHORIZATION CAN BE OBTAINED BY CALLING SEALEVEL SYSTEMS AND REQUESTING A RETURN MERCHANDISE AUTHORIZATION (RMA) NUMBER.**

**Sealevel Systems, Incorporated**  
2779 Greenville Highway  
P.O. Box 830  
Liberty, SC 29657 USA  
(864) 843-4343 FAX:(864) 843-3067  
[www.sealevel.com](http://www.sealevel.com)  
email: [support@sealevel.com](mailto:support@sealevel.com)

Technical Support is available from 8 a.m. to 5 p.m. Eastern time.  
Monday - Friday

---

### Trademarks

Sealevel Systems, Incorporated acknowledges that all trademarks referenced in this manual are the service mark, trademark, or registered trademark of the respective company.

**VERSA COMM+4/EX** is a trademark of Sealevel Systems, Incorporated.